

Product	Benefits	Technology	ISO viscosity grades	Specifications and approvals <small>(Full details of approvals for all products can be obtained from your Shell representative; approvals and claims will vary by viscosity grade.)</small>
Shell <b>Morlina S4 B</b>	<ul style="list-style-type: none"> <li>■ Extra long life</li> <li>■ Extra protection</li> <li>■ Severe applications</li> </ul>	Synthetic, mild EP	220, 320	Approved by or meets Alfa Laval Group D (gearboxes), Aerzener Maschinenfabrik (blowers), Baltimore Aircoil (gearboxes), Cincinnati Machine, David Brown and many other equipment manufacturer approvals and listings Industry standards: ISO 12925-1 type CKS; ISO 150 VG
Shell <b>Morlina S2 B</b>	<ul style="list-style-type: none"> <li>■ Versatile protection</li> <li>■ Industrial applications</li> </ul>	Conventional, non-EP	68, 150, 220	Approved by or meets: Morgan Margoil® – New Oil (Rev. 1.1); and Danieli Standard Oil 6.124249.F (ISO 100-460) Industry standards: DIN 51517-2 type CL
Shell <b>Morlina S2 BL</b>	<ul style="list-style-type: none"> <li>■ Reliable protection</li> <li>■ High-speed applications</li> </ul>	Low-viscosity base oils, non-EP	5, 10	Approved by or meets Cincinnati Machine P-65 (ISO 2); Cincinnati Machine P-62 (ISO 5, 10); and Cincinnati Machine P-45 (ISO 22)
Shell <b>Morlina S1 B</b>	<ul style="list-style-type: none"> <li>■ Reliable protection</li> <li>■ Special applications</li> </ul>	Conventional, non-EP	100, 150, 220, 320, 460, 680	Approved by or meets Morgan Margoil® – New Oil (Rev. 1.1) Industry standards: DIN 51517-1 type C

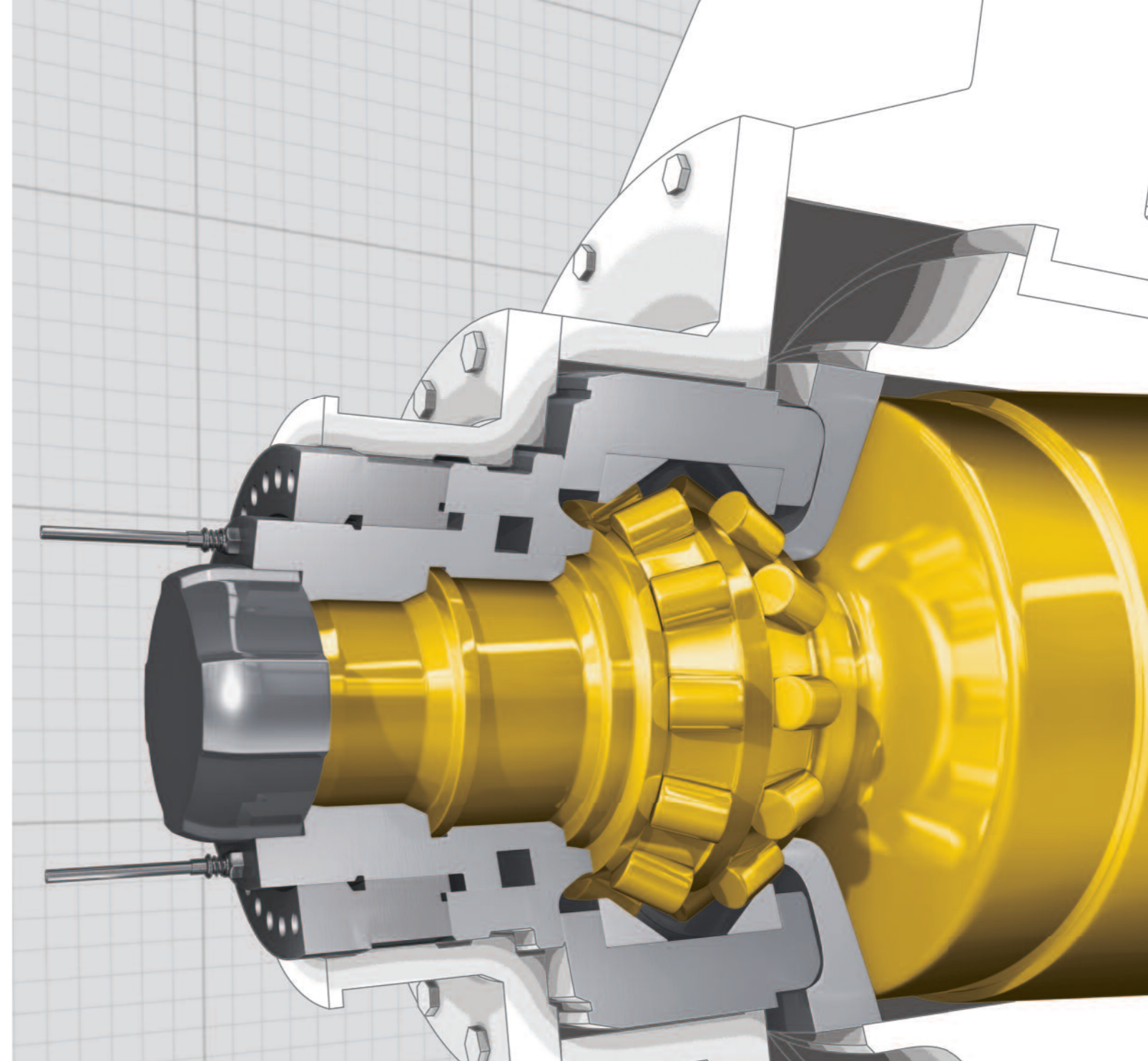

**DESIGNED TO KEEP PRODUCING RESULTS.**

**JUST LIKE OUR BEARING AND CIRCULATING OILS – SHELL MORLINA.**

**DESIGNED TO MEET CHALLENGES**



### FULL PRODUCT AND SERVICE PORTFOLIO

Shell Lubricants is named a global leader in lubricants (Kline & Company 2009) and has a 60-year history of innovation. We are constantly investing to develop better lubrication solutions, as demonstrated by

- Shell Omala S4 GX synthetic gear oil – for long life in demanding environments
- Shell Corena S4 R air compressor oil – for up to 12,000 hours of protection.

In addition, Shell provides the excellent Shell LubeAnalyst oil condition monitoring service, which is designed to help you improve your business performance.

Whatever your needs or application, Shell can provide a full range of oils and greases, including synthetic, high-performance products and additional services.



For more information, please contact



[shell.com/lubricants](http://shell.com/lubricants)

**EVERY PART OF YOUR MACHINE OR PROCESS HAS BEEN METICULOUSLY ENGINEERED, SO YOU WANT TO BE SURE THAT YOU CHOOSE A LUBRICANT THAT HAS BEEN DESIGNED TO ENSURE THAT YOUR EQUIPMENT IS WELL PROTECTED AND WORKS EFFICIENTLY.**

The Shell Morlina range of bearing and circulating oils has been developed to enable equipment operators to select the oil that will deliver optimum value to their operations through enhanced wear protection, long oil life and high system efficiency.

### WEAR PROTECTION

Lubrication systems for industrial equipment differ considerably across industries in size, loading, operating conditions, temperatures and exposure to contamination. But whatever your application, bearings, gears and oil pumps must be well protected from wear and corrosion for long machine life.

That is why Shell offers a range of bearing and circulating oils ranging from robust, reliable products to fully synthetic products fortified with extreme-pressure (EP) additives. There are also speciality products designed to cope with hot, wet or dusty environments, or high-precision operations.

### OIL LIFE

The longer the oil life, the less fluid maintenance is required to help your equipment to operate for longer without interruption. The Shell Morlina range of bearing and circulating oils enables you to match the oil life of the fluid to your operational needs. This includes the fully synthetic Shell Morlina S4 B, which offers the longest oil life in the Shell range under severe conditions, and speciality products that continue to function even when very contaminated with water, dust or dirt.

### SYSTEM EFFICIENCY

Efficient systems are characterised by their ability to operate at or beyond their original design parameters. Consistent and reliable lubrication, whatever the operating conditions, is key. As every application brings specific challenges, the Shell Morlina range is designed to provide a choice of oils that can help to optimise system efficiency.







## A RANGE OF BEARING AND CIRCULATING OILS DESIGNED TO MEET YOUR NEEDS

To meet the challenges of a wide range of equipment designs and applications, Shell has designed a portfolio of oils that enables you to choose a product to match your technical and operational needs.

### PRODUCT NAME SUFFIX KEY

- B** = Bearings
- L** = Low load

### APPLICATION ICON KEY

-  Roller bearing
-  Enclosed gear
-  High load
-  Extreme high temperature
-  Plain bearing
-  Factory/machine applications

### THE SHELL MORLINA "B" RANGE

Bearing and circulating oils with a range of protection and performance levels for a wide range of industrial applications

### THE SHELL MORLINA "BL" RANGE

Extra-low viscosity grades for use in high-speed machine spindle applications

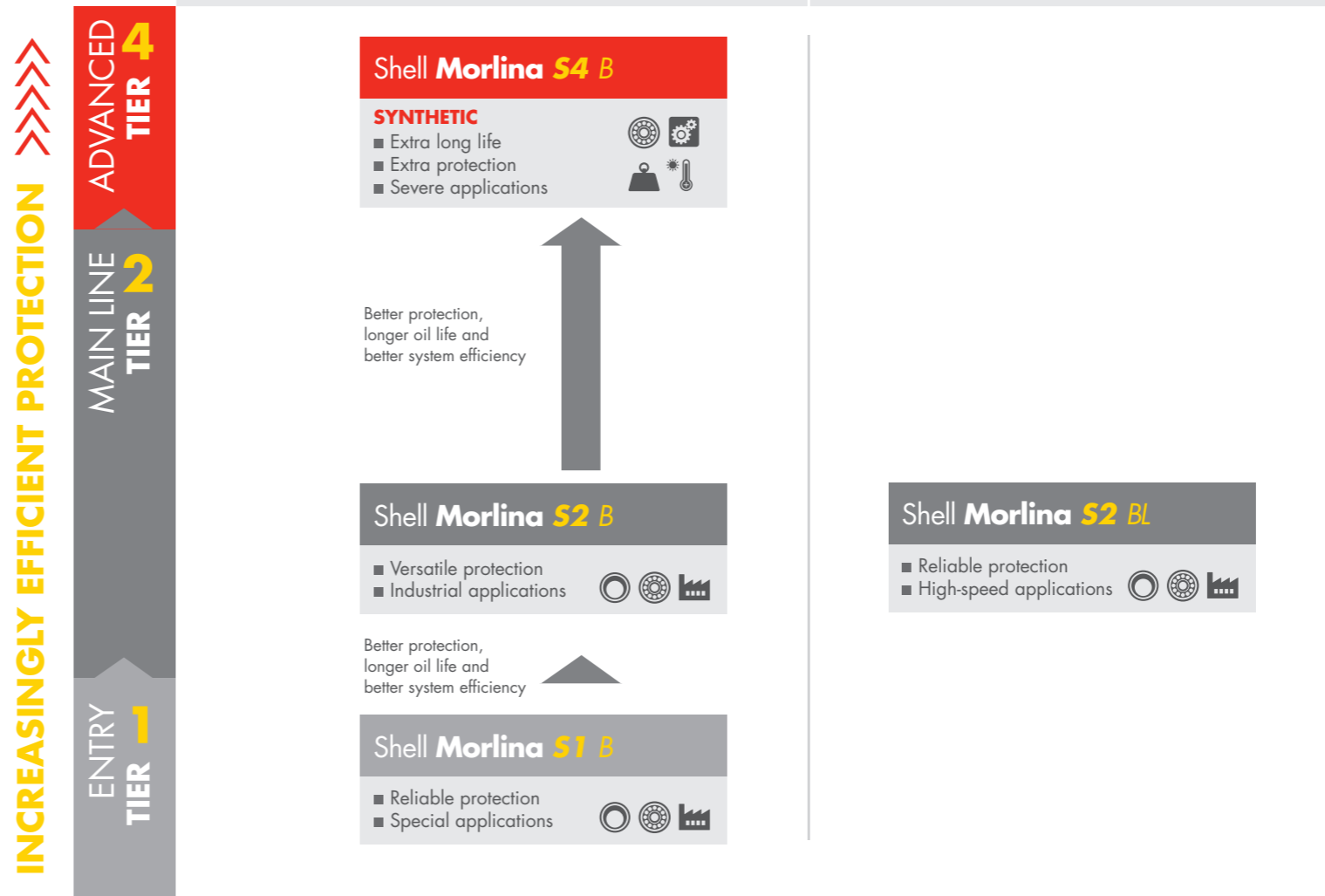

INCREASINGLY EFFICIENT PROTECTION

ADVANCED TIER 4  
MAIN LINE TIER 2  
ENTRY TIER 1

#### Shell Morlina S4 B

##### SYNTHETIC

- Extra long life
- Extra protection
- Severe applications



Better protection, longer oil life and better system efficiency

#### Shell Morlina S2 B

- Versatile protection
- Industrial applications



Better protection, longer oil life and better system efficiency

#### Shell Morlina S1 B

- Reliable protection
- Special applications



#### Shell Morlina S2 BL

- Reliable protection
- High-speed applications



### OUR EXPERTISE, YOUR REASSURANCE

Shell Morlina oils have been designed and developed in close co-operation with customers and equipment makers, and have a proven track record in real-life applications. They are recommended or approved by leading equipment makers and users around the world so you can be assured that they will not let you down.

### RESPONDING TO YOUR NEEDS – SHELL MORLINA S4 B

Using fully synthetic bearing and circulating oils, such as Shell Morlina S4 B, can bring significant savings to operators of heavy industrial equipment or where operating conditions are hot and severe. For instance, by switching from a conventional product, one customer reports

- increasing oil life by 400%
- reducing bearing damage
- increasing the value of production output by over \$80,000<sup>1</sup> a year.

<sup>1</sup>“Shell Lubricants” refers to the various Shell companies engaged in the lubricants business.

<sup>1</sup>Saving reported by one customer. Actual savings may vary, depending on the application, the current oil used, the maintenance procedures and the condition of the equipment.

Shell Morlina S4 B – For the longest oil life in the Shell range

